







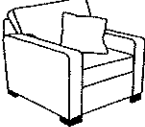
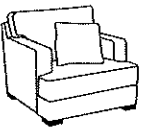

1 Arm	ROLL ARM		TRACK ARM		DOME ARM		FLARE ARM	
2 Seat style	boxed seat	t-cushion	boxed seat	t-cushion	boxed seat	t-cushion	boxed seat	t-cushion
Upholstered base	 S0401 ORION F0401 ORION	 S0407 HERMES F0407 HERMES	 S0412 JUNO F0412 JUNO	 S0403 NEPTUNE F0403 NEPTUNE	 S0413 ARTEMIS F0413 ARTEMIS	 S0414 ARIES F0414 ARIES	 S0420 SCORPIO F0420 SCORPIO	 S0423 AQUARIUS F0423 AQUARIUS
3 Wood base	 S0408 ZEUS F0408 ZEUS	 S0402 APOLLO F0402 APOLLO	 S0405 GEMINI F0405 GEMINI	 S0409 KRONOS F0409 KRONOS	 S0418 TAURUS F0418 TAURUS	 S0415 PISCES F0415 PISCES	 S0421 LIBRA F0421 LIBRA	 S0424 SAGITTARIUS F0424 SAGITTARIUS

4 Seat cushion

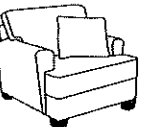
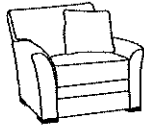
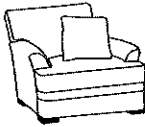
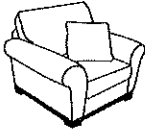

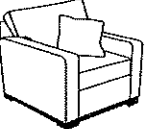
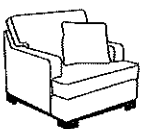
**Standard Seating (S)**  
1.8 Density HR Core  
Low Melt Dacron Wrap

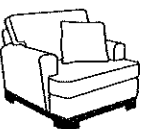
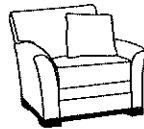
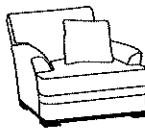
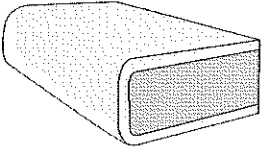
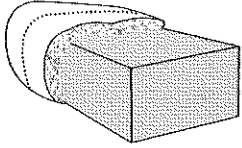

**Pluma Plush Seating (F)\***  
1.8 Density HR core  
Encased in a "featherbarrier,"  
205 thread count, 100% cotton bag  
filled with 100% Water Fowl feathers  
*\*Available at an upcharge.*

### SWIVEL SUIT CHAIR

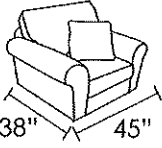

ORION  
S025016XXX  
F025016XXX

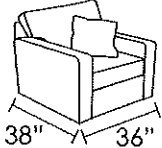

JUNO  
S025116XXX  
F025116XXX

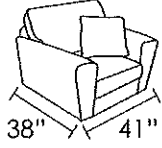

ARTEMIS  
S025216XXX  
F025216XXX

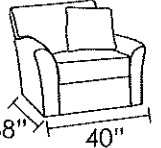

SCORPIO  
S025316XXX  
F025316XXX

Swivels available with boxed seat / upholstered base only.

### STORAGE OTTOMANS

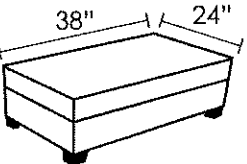

S040362XXX NEPTUNE  
F040362XXX NEPTUNE

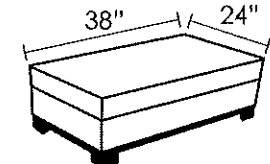

S040262XXX APOLLO  
F040262XXX APOLLO

Storage ottomans are available with upholstered base / wood base.

*Choices* by JONATHAN J. LOUIS

