

Jonathan Louis was founded in 1985 by two brothers who have a passion for fashion and comfort. Their fine furniture is made in the USA, in Gardena, California. Today, a second generation of family members source quality materials and helps to create their on-trend designs. All of this style combined with affordable prices makes Jonathan Louis a perfect choice for the value-conscious shopper!

MAKE IT YOUR OWN!

The Tresa estate sofa is stocked in the fabrics shown. Customize the Tresa by special order, choosing from a wide variety of fabrics located in the Design Center.

HOW TO ORDER

- 1 Choose Your Piece(s)
- 2 Choose Your Fabric

AVAILABLE PIECES AND CONFIGURATIONS

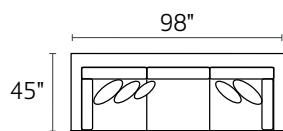

38970 - ESTATE SOFA

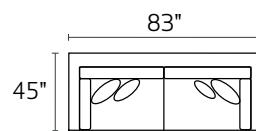

38930 - SOFA

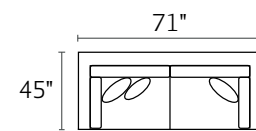

38960 - CONDO SOFA

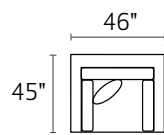

38901 - ARM CHAIR

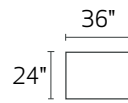

38902 - OTTOMAN

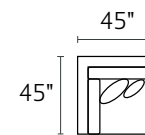

38915 - CORNER UNIT

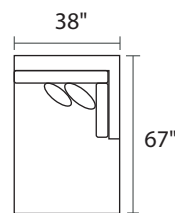

38982R - RAF CHAISE

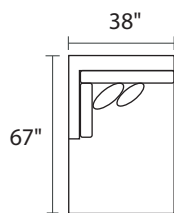

38982L - LAF CHAISE

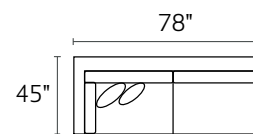

38935L - LAF SOFA

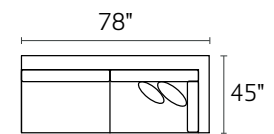

38935R - RAF SOFA

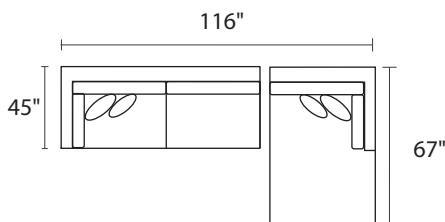

-35L / -82R

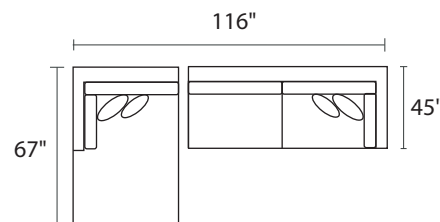

-82L / -35R

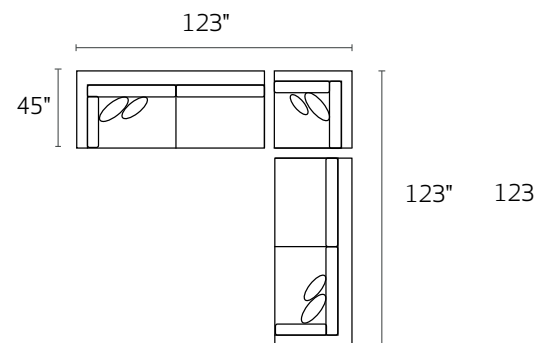

-35L / -15 / -35R

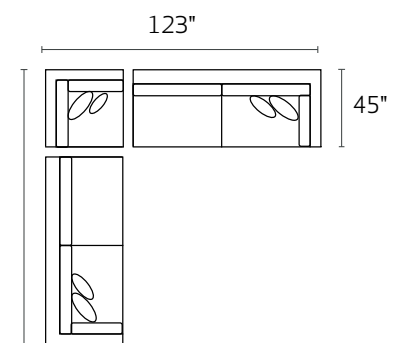

-35L / -15 / -35R