

Standard / Ottomans / Armless

Put Green Arrows with Red Arrows to Create Sectional Groups

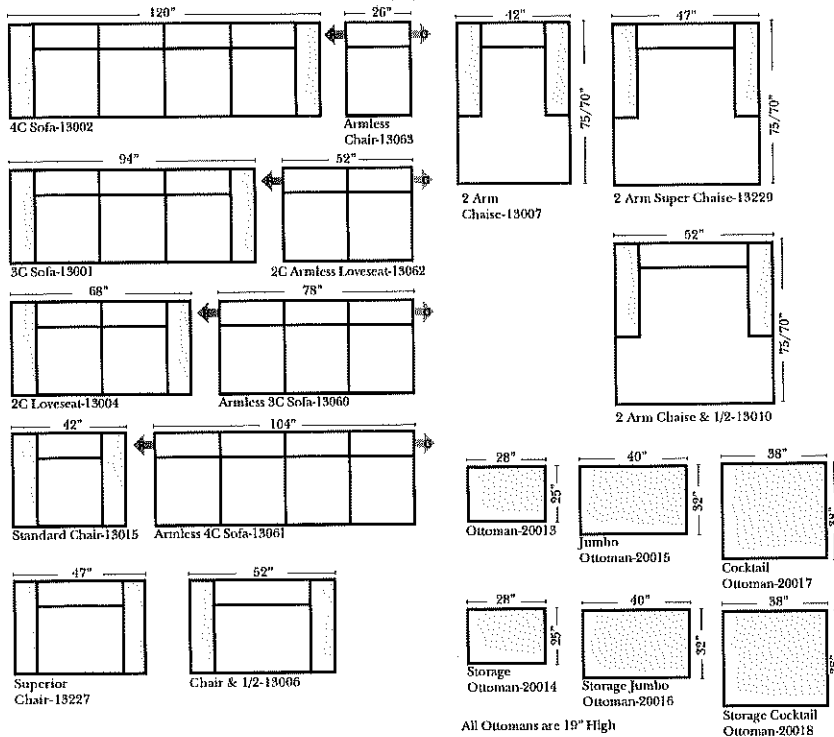

Additional Sectional Items

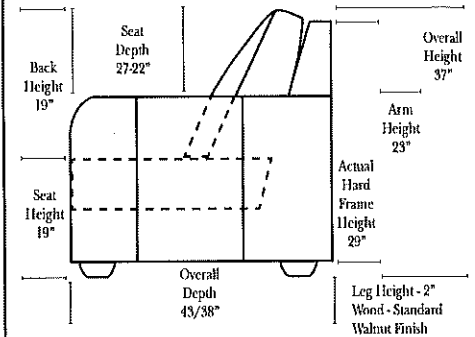
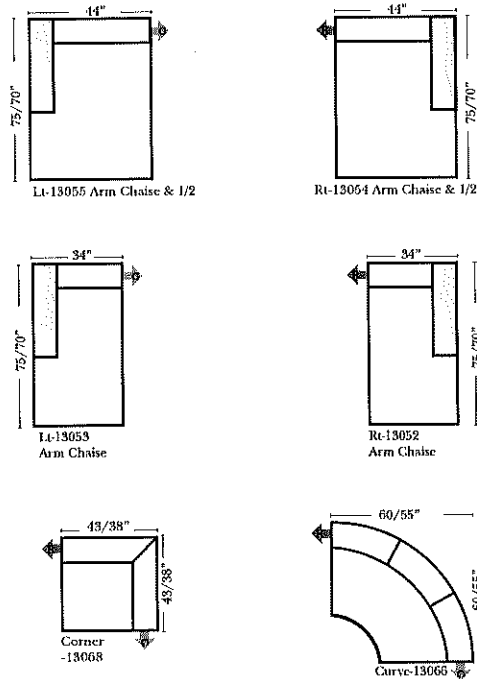

Standard & options

Standard:

- Available in Full & Top Grain Leathers
- Available in Luxury Fabrics
- All Hardwood Frames
- Wood Leg Finish (Standard is Walnut)

Options: (No Additional Charge)

- No. 33 Firm Foam Cushions
- Wood Leg Finish (Available in Cherry, Chocolate, Espresso, Honey Oak, & Shadow)

Options: (additional Charge)

- Down Seats & Down Backs
- Upholstered Swivel Base (2 arm Chair Only) (Not available on Super Chair or Chair & 1/2)

Sleeper Options: (N/A on this Style)

L-Shape / 90 Degree Sectional

(All 4 seat items ship as one piece if stationary, two pieces if motion installed)

Put Green Arrows with Red Arrows to Create Sectional Groups

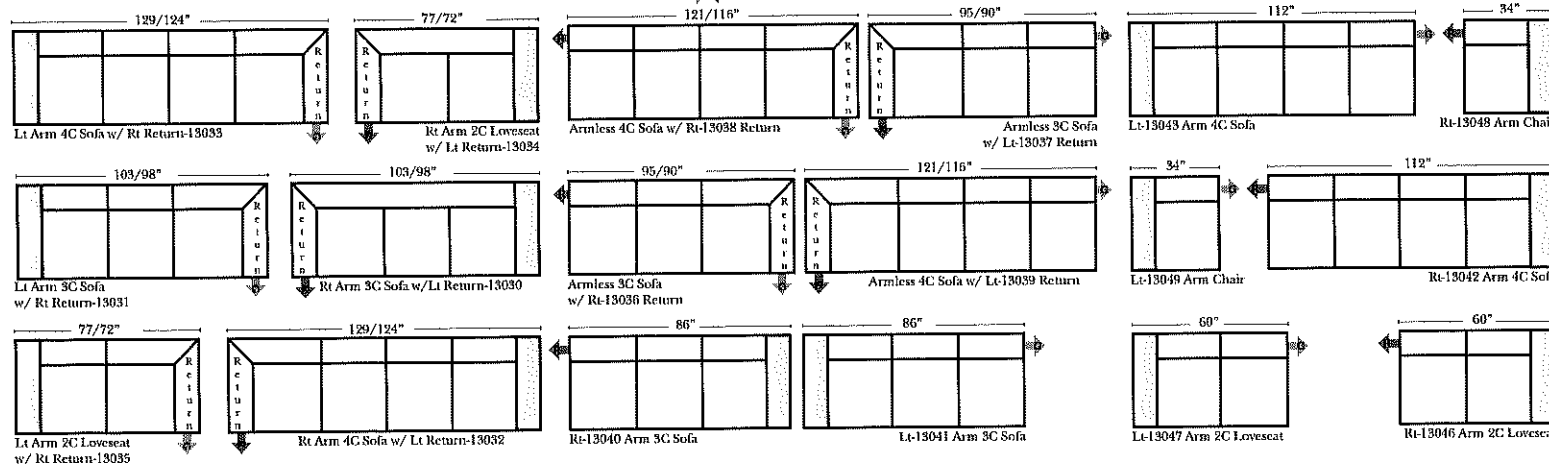

Overall LENGTH dimension will change on sectionals depending on Model seat depth.

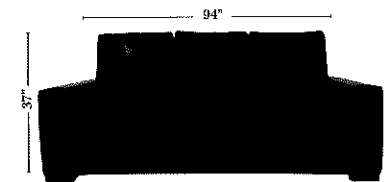

Note:

All Dimensions are approximate, if accuracy is crucial, please contact us for validation of the dimensions shown. However, a 1" to 2" variance can still apply due to foam and upholstery.

Customer Last Name:

Sales Order Number:

Customer Signature:

Date:

Bumper / Return Chaise & Conversation Sofas

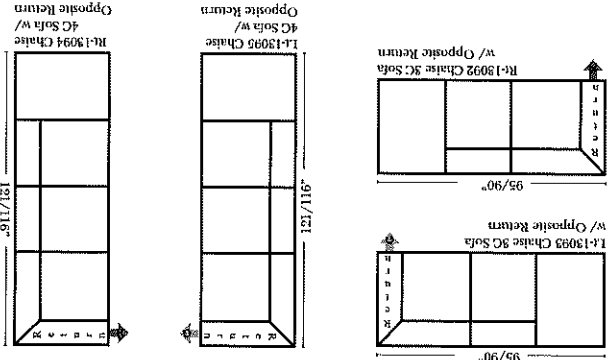

Put Green Arrows with Red Arrows to Create Sectional Groups



Put Orange Arrows with Tan Arrows to Create Sectional Groups

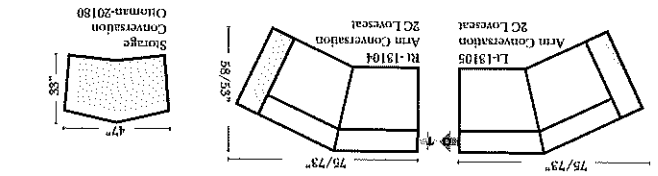
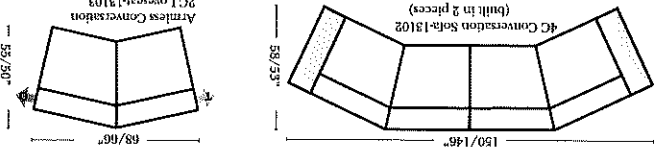

Sleepers

Sleepers

Sleepers not available for this style

Put Green Arrows with Red Arrows to Create Sectional Groups



Put Blue Arrows with Yellow Arrows to Create Sectional Groups



v.09.15.20

Suggested Configurations

Circle Piece(s) Being Ordered
 Base Leather / Fabric:
 Pillow(s) only available on all fabric frame.
 Pillow (18") Fabric:

The Suggested Configurations below are only a sample of what the imagination can create, please enjoy creating the configuration that fits your lifestyle, using the ideas below and from the items on the opposite page.

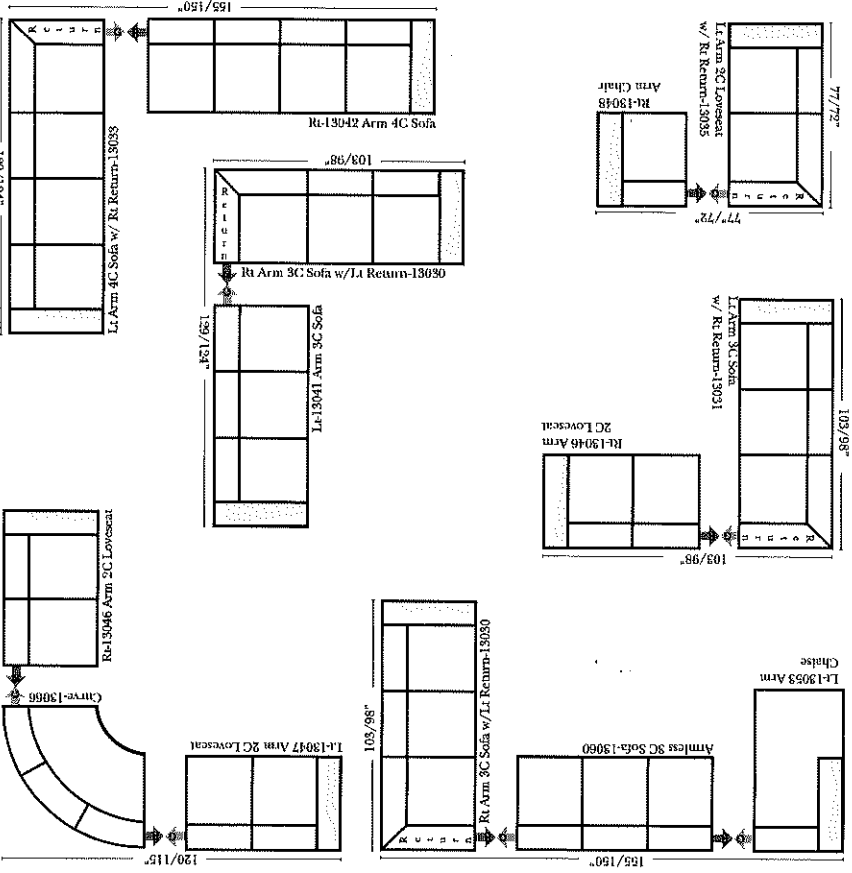

Sleepers (Cont.)

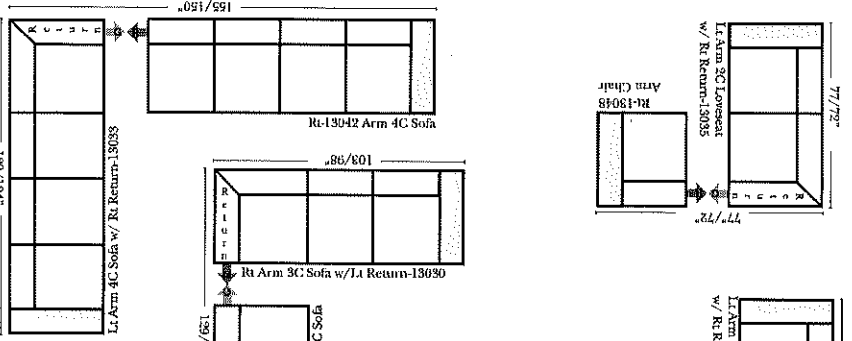

OMNIA®

Personalizing Comfort™

MODERNO

Model 852 24" Seat Width
 Model 860 28" Seat Width
 Model 853 32" Seat Width

24 / 28 / 32 Pre-Configured Items

v.09.15.20

24" Items

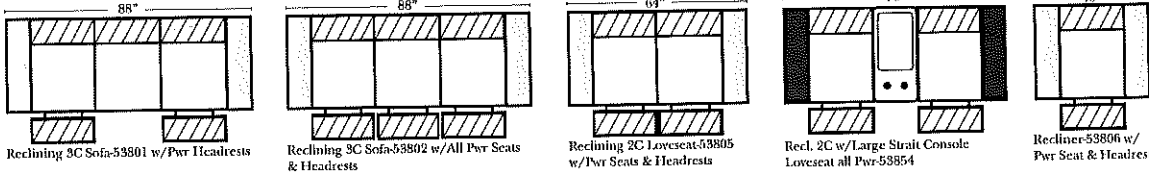

Reclining 3C Sofa-53801 w/Pwr Headrests
 Reclining 3C Sofa-53802 w/All Pwr Seats & Headrests
 Reclining 2C Loveseat-53805 w/Pwr Seats & Headrests
 Recl. 2C w/Large Strait Console Loveseat all Pwr-53854
 Recliner-53806 w/Pwr Seat & Headrest

28" Items

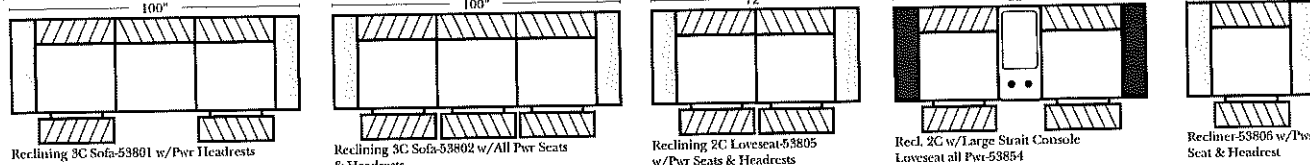

Reclining 3C Sofa-53801 w/Pwr Headrests
 Reclining 3C Sofa-53802 w/All Pwr Seats & Headrests
 Reclining 2C Loveseat-53805 w/Pwr Seats & Headrests
 Recl. 2C w/Large Strait Console Loveseat all Pwr-53854
 Recliner-53806 w/Pwr Seat & Headrest

32" Items

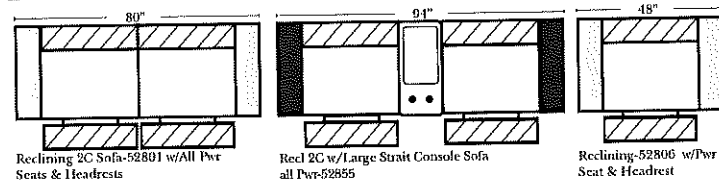

Reclining 3C Sofa-52801 w/All Pwr Seats & Headrests
 Recl 2C w/Large Strait Console Sofa all Pwr-52855
 Reclining-52806 w/Pwr Seat & Headrest

Standard: All Reclining seats are powered. All Headrests are powered.

Put Green Arrows with Red Arrows to Create Sectional Groups

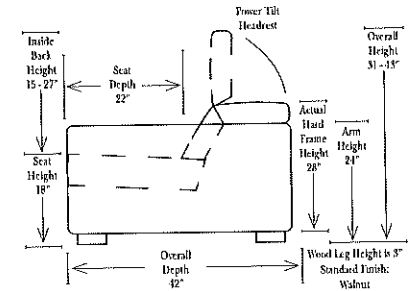

Standards & Options

Standard:

- Available in Full & Top Grain Leathers
- Available in Luxury Fabrics
- All Hardwood Frames
- Wood Leg Finish (Standard is Walnut)
- Power Recliner & Power Headrests on seats next to each Arm
- Stationary items have Power Headrests only
- Power toggle controller with USB charging port for each power recliner or headrest

Options: (No Additional Charge)

- No. 33 Firm Foam
- Wood Leg Finish (Available in Cherry, Chocolate, Espresso, Honey Oak, & Shadow)
- 3" Metal Leg (Except Ponza)

Options: (Additional Charges Apply)

- Rechargeable Battery Pack (will operate 2 recliner footrests or multiple mechanisms per recliner)
- Swivel Table for Console Arms (Espresso or Walnut Wood Finish)
- ** Portable Single Theater Arm (1) Cup Holder or *** Portable Double Theater Arm (2) Cup Holders (Black, Hammered Antique, or Silver Cup Holders) (Fabric or Leather)

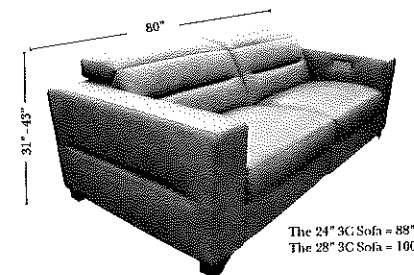

The 24" 3C Sofa = 88"
 The 28" 3C Sofa = 100"

Note:

All Dimensions are approximate, if accuracy is crucial, please contact us for validation of the dimensions shown. However, a 1" to 2" variance can still apply due to foam and upholstery.

Customer Last Name: _____

Sales Order Number: _____

Circle Piece(s) Being Ordered

Base Leather / Fabric: _____

Pillow(s) only available on all fabric frame. Pillow fabric: _____

Customer Signature: _____

Date: _____

